

2018

THE COMPLETE LIFESTYLE COLLECTION



ABOVE & BEYOND



EXPLORE

Here's to the explorers. To the searchers. To the people who go off the map. Whose curiosity stops at nothing. Here's to the people who believe there's always more to know about the world. This Land Rover Collection is created specifically for them. Apparel and accessories that are forged from the same spirit of adventure, and ready for anything. Go explore.

Darién Gap – Heritage Collection	06–17
Lifestyle Collection	18–29
Kids' Collection	30–45
Hue 166 Collection	46–51
Watches	52–53
Luggage	54–57
Barbour for Land Rover Dog Accessories	58–59
Scale Models	60–61
Range Rover Collection	62–67
Size Guide	68–69





Image: Loren Ipsum Color Strainer



ENDURE

In December 1971, two Range Rover crews took on the ultimate test of endurance.

They set out on a formidable 18,000 mile journey across the Americas that led them through the Darién Gap. 250 miles of swamplands and rainforest between Columbia and Panama. Here, man and machine took on some of the most dangerous terrain on the planet and endured. To this day their achievement is known as one of the most remarkable expeditions ever attempted.



BRITISH TRANS - AMERICAS

8°9'N 77°41'W

DARIÉN GAP

8°6'N 76°40'W

EXPEDITION 1971 - 72

CHALLENGE

Relive the epic Darién Gap challenge with the 2018 Land Rover Heritage Collection. A premium range of clothing, gifts and accessories. Born from a spirit of resilience and created from the finest materials, the collection features heritage detailing, technical graphics and the navy and gold of those original Range Rovers. It's what British icons are made of.



1.

2.



1.



1. WOMEN'S HERITAGE LEATHER JACKET

This classic soft-handle leather jacket brings style to every terrain. Features a tropics motif on the lining and official Darién Gap plaque. Cut to a feminine fit with distinctive panelling on the shoulders, copper-effect poppers and an adjustable belt.

51LDJW595NV – Navy £395.00

2. MEN'S HERITAGE LEATHER JACKET

An iconic leather field jacket inspired by an epic journey. Crafted from supple leather with a Range Rover schematic on the lining, woven story panel and official Darién Gap plaque. Features four deep front pockets, adjustable belt and copper-effect poppers.

51LDJM585BN – Brown £425.00



1.

It was that sort of expedition where if common sense had prevailed, we'd have packed up and pulled out.

COLONEL JULIAN DU PARC BRAHAM



3.

1. WOMEN'S HERITAGE GRAPHIC T-SHIRT

Mark a historic journey with this exclusive Darién Gap tee. Cut to a feminine fit with a flattering shape. Features soft-handle expedition logo, and heritage map trim inside.

51LDTW596NV - Navy £25.00

2. HERITAGE DARIÉN GAP WALLET

A wallet with history. Made from smooth leather with a Tan interior. Features embossed Darién Gap expedition detailing. With note pocket, six card slots and receipt pockets.

51LDLG660NVA - Navy £60.00

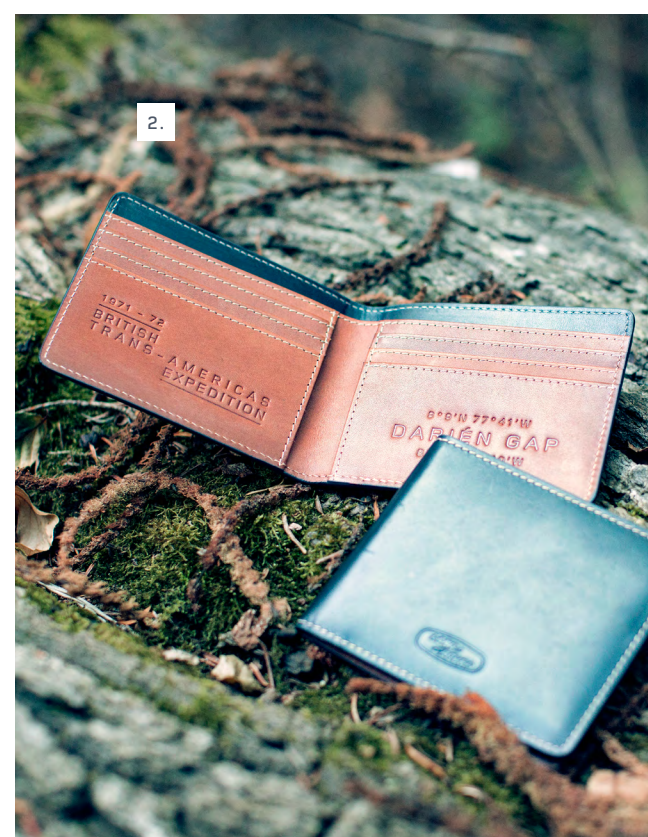

2.

3. HERITAGE HOLDALL

The holdall that's made from pure heritage. Navy with a canvas body and contrasting brown leather trim. Includes detailing to the front pocket and brass finish fastenings.

51LDBC603NVA - Navy £150.00



1. MEN'S HERITAGE FULL ZIP SWEATSHIRT

Official expedition hoodie. A petrol Blue full-zip sweatshirt with quilted elbow patches. Features embroidered Darién Gap expedition detailing and includes pull-cord with logo.

51LDHM586NV - Navy £65.00



2. HERITAGE BACKPACK

The go-anywhere, take-anything backpack. Made from cotton canvas and leather and featuring Darién Gap Expedition detailing. Features large interior compartment and exterior pocket.

51LDBC602NVA - Navy £95.00



1.



2.

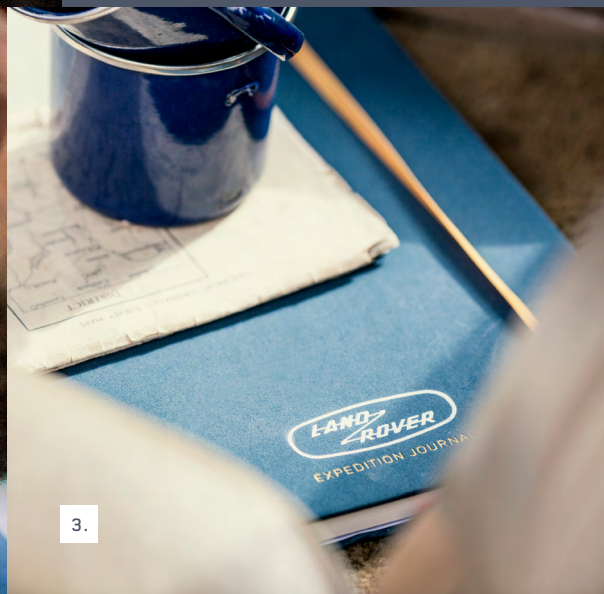

3.

1. UNISEX HERITAGE CAP

Made from a wool mix with a Tan faux leather peak. Heritage embroidered logo to the front and Darién Gap map detailing to the side. Adjustable strap and metal finish fastenings.

51LDCH594GMA – Grey Marl £20.00

2. UNISEX HERITAGE SCARF

Accessorise your everyday adventures with this unisex scarf in Ochre and Navy. Designed with a Darién Gap map and terrain motif, it's light and stylish. An essential piece of Land Rover heritage.

51LDSF597BNA – Ochre/Navy £30.00



Darién Gap - Heritage collection

2.

3. HERITAGE DARIÉN GAP NOTEBOOK A4

Keep track of your daily adventures in this A4 notebook, with Darién Gap expedition map printed inside. Includes 96 lined sheets of recycled paper.

51LDNB615NVA – Navy £14.00

4. HERITAGE DARIÉN GAP MUG SET X 2

Commemorate the expedition with a set of two matte-finish porcelain mugs. Featuring a Darién Gap expedition map and original Range Rover schematic diagrams.

51LDMG611NVA – Navy £22.00



4.



1. MEN'S HERITAGE POLO SHIRT

Made from 100% cotton and styled with pure heritage. Features an embroidered front pocket, double piping on the collar and Darién Gap expedition trim at the neck.

- 51LDPM593GM – Grey Marl £40.00
- 51LDPM593NV – Navy £40.00

2. UNISEX HERITAGE BELT

Buckle up for the journey with this plaited Navy belt. Features metal buckle, leather trim and embossed Land Rover heritage logo to the front.

- 51LDGF604NV – Navy £45.00



LIFESTYLE COLLECTION

ESCAPE

Our Lifestyle Collection is prepared for anything your life has in store. Made from rugged, lightweight and durable fabrics, this collection is designed for style and built to last. Apparel from a classic British brand, and accessories that take adventure to the next level.





1. MEN'S 2 IN 1 JACKET

A technical jacket for all seasons. Comes with removeable inner quilted coat, down filling and heat reflective lining. Wind and water resistant outer jacket made from 100% polyester. Features discovery inspired stitching to the reverse.

51LBJM306GY – Grey £190.00



2. WOMEN'S GILET

Woman's Navy Gilet with a mixed down filling. Features Land Rover wordmark to the front and Terrain Response® icons to the back. Folds away easily into pouch.

51LDJW849NV – Navy £145.00

3. MEN'S FULL ZIP HOODIE

The out-and-about hoodie features tonal grille pattern embroidery to inner hood, side pockets and oval branding on the chest.

51LDHM950NV – Navy £55.00
 51LDHM950GM – Grey Marl £55.00
 51LCHM324GN – Green £55.00

4. MEN'S UNION FLAG GRAPHIC T-SHIRT

100% cotton comfort. Features Land Rover oval flag print logo on the chest and Land Rover branding to one side.

51LATM016WT – White £25.00
 51LATM016NV – Navy £25.00
 51LATM016GM – Grey Marl £25.00
 51LBTM088GN – Green £25.00

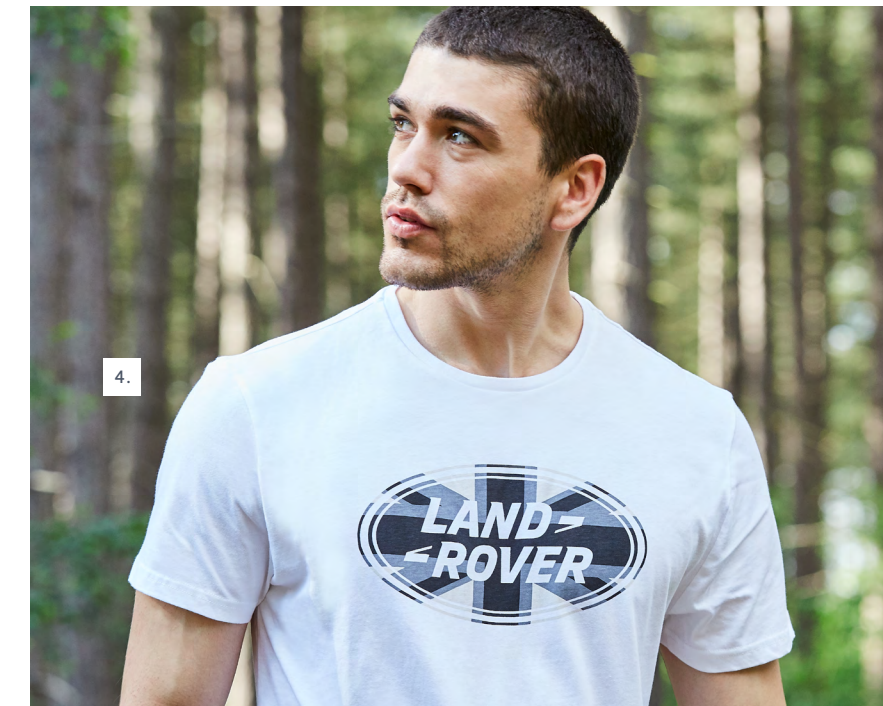



1.

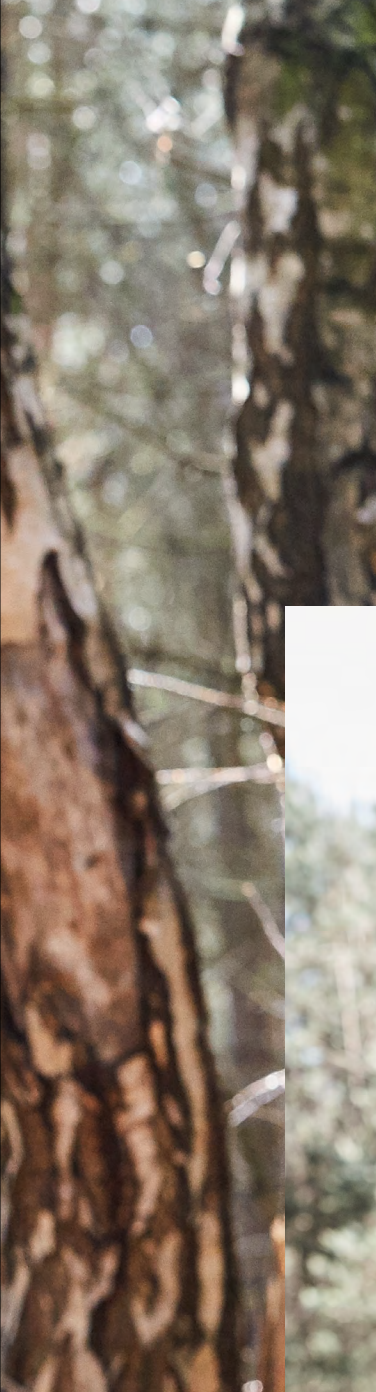

3.

1. WOMEN'S DRIVERS JACKET

Ease behind the wheel in this textured nylon jacket. Robust and durable with panelling to the shoulders. Quilted lining features Land Rover grille pattern. Silicone Land Rover wordmark badge on chest.

51LDJW649BK – Black £90.00

2. MEN'S DOWN JACKET

Outstanding protection for the outdoors. Features warming mixed down filling, and stylish detailing. With inner headphone loops and Terrain Response® icons to the back.

51LDJM643NV – Black £175.00



2.

3. MEN'S DRIVERS JACKET

Suit up in this classic Drivers Jacket. Features quilted shoulder panels, Matte-Black poppers and faux leather trim. With Land Rover wordmark branding, with raised collar and zip chest pocket.

51LAJK041GY – Black £95.00



1. UNISEX HAT AND SCARF SET

Grey unisex chunky knit hat and scarf set. Pattern inspired by the Land Rover front grille. Features small metal plaque with the Land Rover wordmark.

51LBGF348GM – Grey £40.00

2. WOMEN'S DOWN JACKET

Weather-proof jacket insulated with mixed down filling. Features stylish detailing, inner headphone cable loops and Terrain Response® icons at the back. Folds away into easy-carry pouch.

51LDJW848NV – Navy £170.00



3. MEN'S FULL ZIP FLEECE

Stay warm and keep cool. Created with breathable, vented panels and inner mesh for ventilation. With stitching details, tonal printed Terrain Response® icons to the back and waterproof zips.

51LDJM545BK – Black £60.00

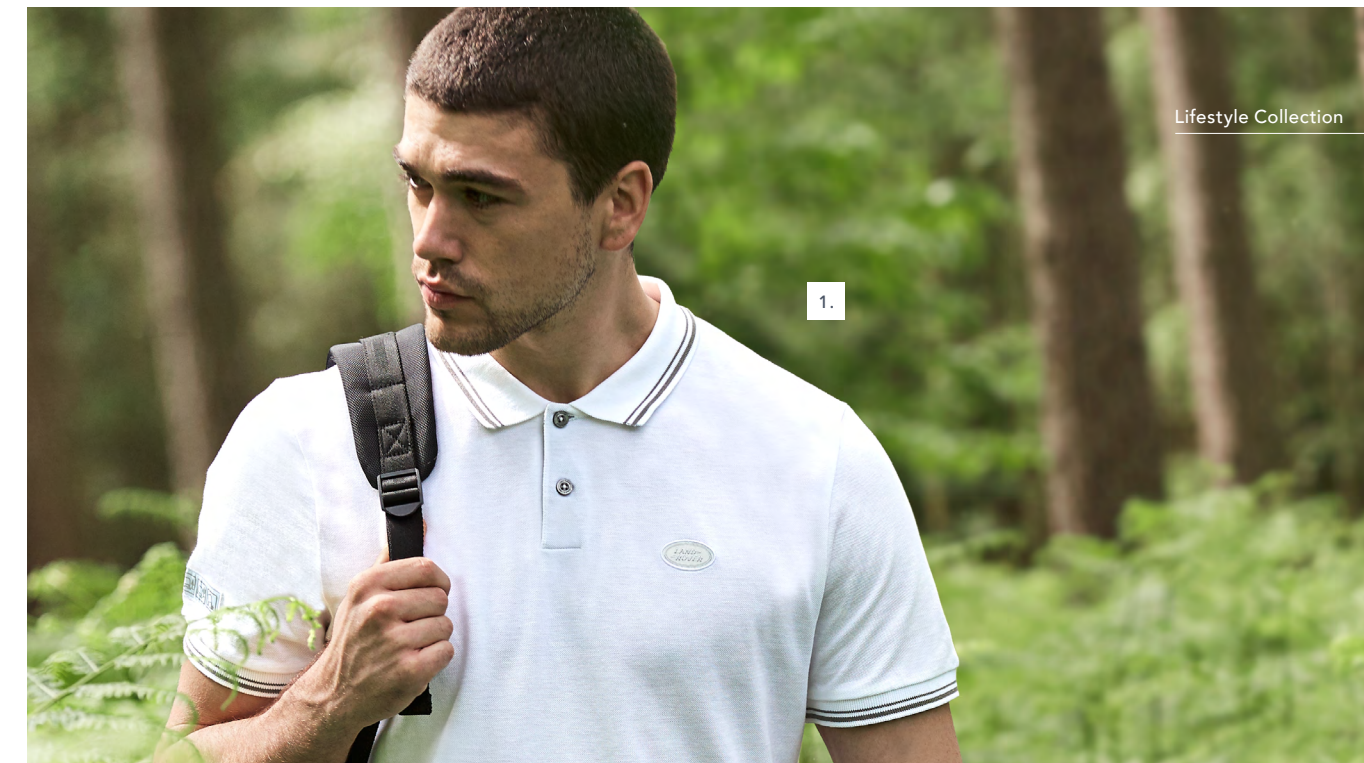

1. MEN'S OVAL BADGE POLO SHIRT

Pure cotton classic polo shirt. Features a Land Rover oval logo to the chest and Terrain Response® icons to the sleeve. Land Rover wordmark tab and split side-seam.

- 51LBPM078GN – Green £30.00
- 51LATM017NV – Navy £30.00
- 51LBPM078WT – White £30.00

2. WOMEN'S GRAPHIC T-SHIRT

Fitted and feminine, this t-shirt is the perfect partner for the journey. With screen printed floral motif to chest and split side-seam.

- 51LCTW329NV – Navy £25.00
- 51LCTW329WT – White £25.00

3. MEN'S FULL ZIP HOODIE

The out-and-about hoodie features tonal grille pattern embroidery to inner hood, side pockets and oval branding on the chest.

- 51LCHM324GN – Green £55.00
- 51LDHM950NV – Navy £55.00
- 51LDHM950GM – Grey Marl 55.00



1. WOMEN'S OVAL BADGE POLO SHIRT
A classic never goes out of style. Made from 95% cotton and 5% elastane piquet and featuring twin-tipping to collar and cuffs. Features two-button placket and split side-seam.

51LAPL011WT – White £28.00
51LBPL120TE – Teal £28.00
51LCPW333CO – Coral £28.00



2. MEN'S TAPED SEAM JACKET

Keep the weather at bay in this technical jacket. Lightweight, showerproof and breathable. Features taped seams and a cord adjustable hemline. Terrain Response® icons to the back.

51LDJM654GY – Grey £185.00

3. WOMEN'S GILET

Keep warm, stay active. A diamond quilted gilet with a feminine fit. Featuring subtle botanical print lining, deep side pockets and Land Rover silicone wordmark logo.

51LCJW331NV – Navy £80.00





KIDS' COLLECTION

SCRAMBLE

Get the little ones set for the great outdoors with this great new collection. Top togs and ace accessories, all designed for micro-adventures. Made from lightweight and durable fabrics, this collection is kid-proof and play-proof. And proof that the fun never has to stop.



1. BOYS' ZIP THROUGH

A zip-up jersey that zips out the cold. Features a pack-away hood, distinctive Alcantara elbow patches and piping. Includes outdoor adventure badges for trainee explorers.

51LDEC568NV – Navy £50.00



2. GIRLS' POLO SHIRT

Let the games begin in this cotton piquet polo. Sporting a graphic print trim to the neck and under the collar. With split side-seams and Land Rover oval to sleeve.

- 51LCPC339PN – Pink £25.00
- 51LDPC571WT – White £25.00
- 51LDPC571GN – Green £25.00
- 51LDPC571PU – Purple £25.00





1. BOYS' POLO SHIRT

Get them ready for anything in this hard-wearing 100% cotton polo shirt. Features contrasting trim on the collar and cuffs, as well as reinforcing cotton patches over the side vents.

- 51LDPC565RD – Red £25.00
- 51LDPC565NV – Navy £25.00
- 51LDPC565GM – Grey Marl £25.00



2. GIRLS' T-SHIRT

Everyday tee for non-stop fun. Made from cotton jersey with soft handle Adventure print and puff sleeves. Featuring Land Rover inspired print inside back neck.

- 51LDTC572PU – Purple £18.00
- 51LDTC572GN – Green £18.00
- 51LDTC572WT – White £18.00

3. LANDY CHILDREN'S BOOK

Meet Landy the Land Rover in this charming children's hardcover book. The first in a series of fun stories following Landy's adventures.

- 51LDGF989NAA £10.99

4. FENDER CHILDREN'S BOOK

Children's hardcover book that recounts the sparky adventures of Fender the Defender. Part of a series exclusive to Land Rover.

- 51LDGF990NAA £10.99

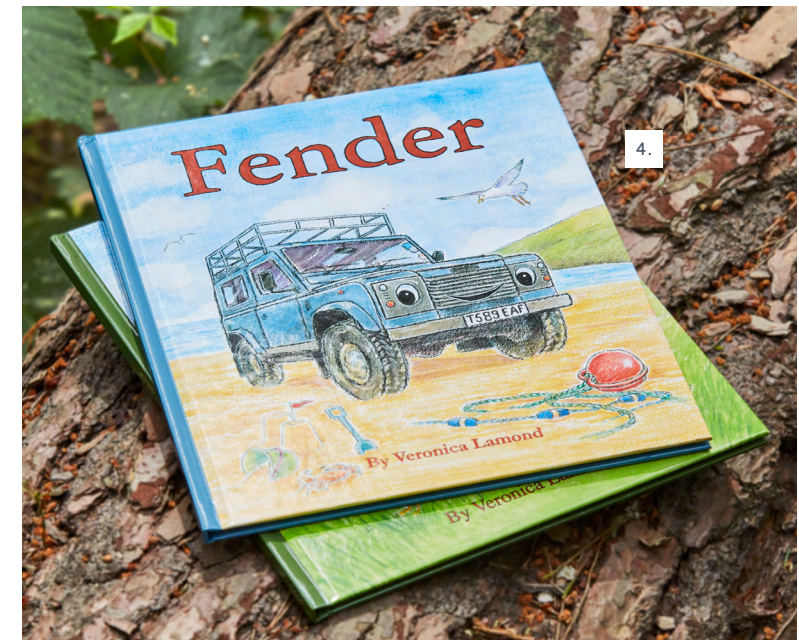



1.

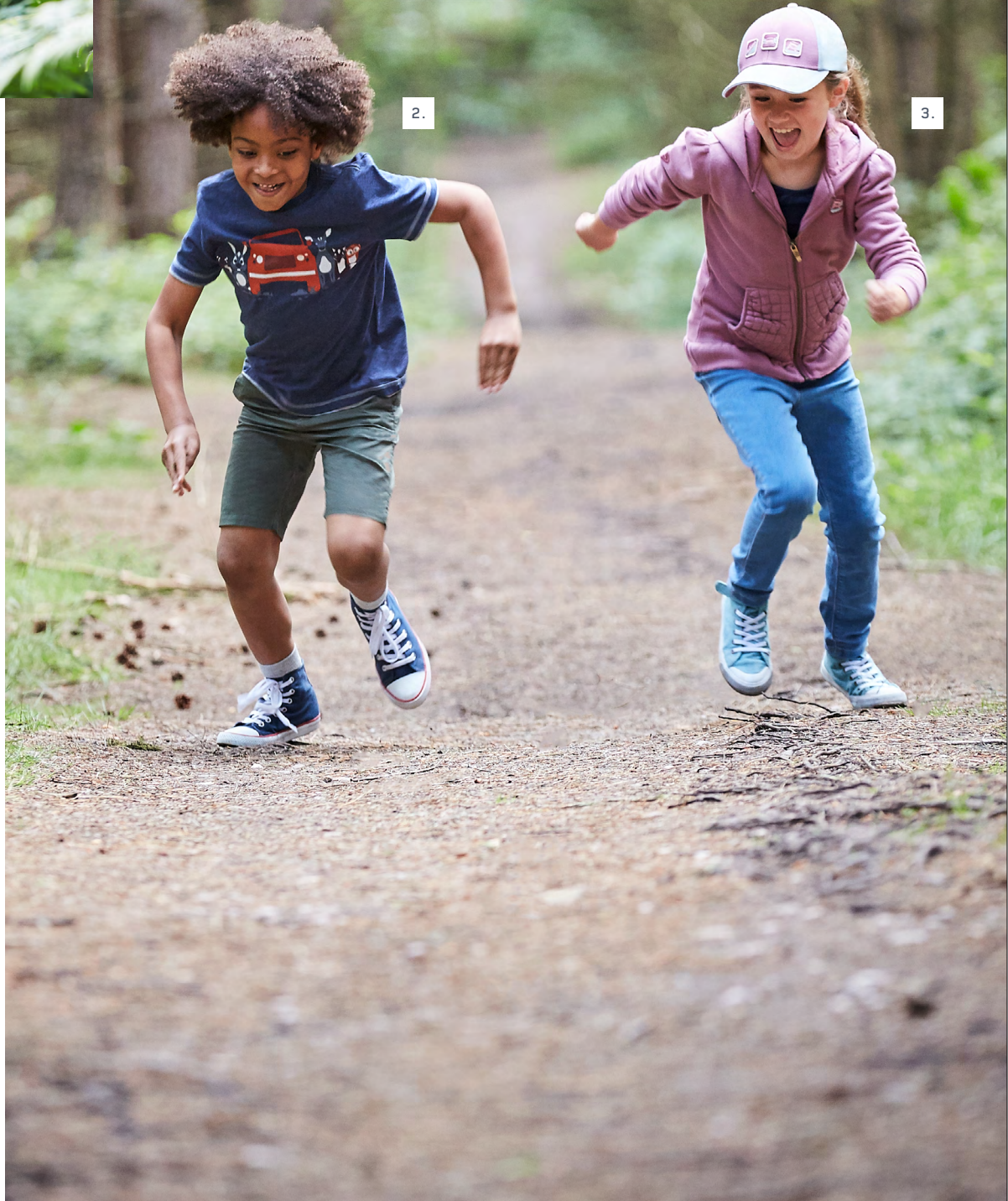

2.

3.

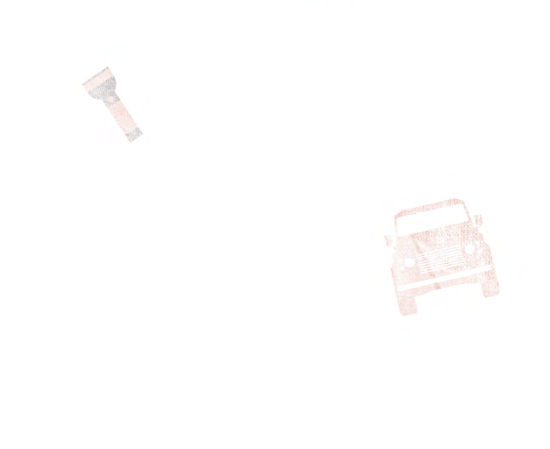

1. GIRLS' GILET

The ultimate gilet for juniors. With diamond-pattern quilting, patch pockets and colourful lining. Finished with logo poppers and a Land Rover Adventure badge.

51LDJC570NV – Navy £45.00
51LCJC338PL – Plum £45.00

2. BOYS' GRAPHIC T-SHIRT

Let them roam free in this all-terrain tee in 100% cotton jersey. Features a Junior Defender graphic on the front with a soft, natural feel. Finished with a Land Rover oval to the sleeve.

51LDTC566NV – Navy £18.00
51LDTC566RD – Orange £18.00
51LDTC566GM – Grey Marl £18.00

3. GIRLS' HOODIE

Meet the hoodie that has it all: cool kangaroo pockets, a fun forest-print lining and a Land Rover adventure badge. Finished with ruched hem and shoulders.

51LDEC574PU – Purple £40.00



2.



4.



4. BOYS' POLO SHIRT

A high energy polo in 100% cotton piquet. Includes dashing patches on the side vents, double contrast piping to the collar and Outdoor Adventure badges.

51LCPC334NV – Navy £25.00
51LCPC355GM – Grey Marl £25.00



1. BOYS' ZIP THROUGH

A zip-up sweatshirt that zips out the cold. Features a pack-away hood, distinctive Alcantara elbow patches and piping. Includes Outdoor Adventure badges for trainee explorers.

51LDEC568NV – Navy £50.00

2. GIRLS' T-SHIRT

Everyday tee for non-stop fun. Made from cotton jersey with soft handle Adventure print and short sleeves. Featuring Land Rover inspired print inside back neck.

51LDTC572GN – Green £18.00
 51LDTC572PU – Purple £18.00
 51LDTC572WT – White £18.00

3. BOYS' POLO SHIRT

Stand out polo for outgoing kids. Made of soft 100% cotton, with three button placket and stylish colour combinations. Features kids' Land Rover icon to the chest.

51LCPC334NV – Navy £25.00
 51LCPC355GM – Grey Marl £25.00

4. GIRLS' GILET

The ultimate gilet for juniors. With diamond-pattern quilting, patch pockets and colourful lining. Finished with logo poppers and a Land Rover Adventure badge.

51LCJC338PL – Plum £45.00
 51LDJC570NV – Navy £45.00

5. BOYS' POLO SHIRT

Get them ready for anything in this hard-wearing 100% cotton polo shirt. Features contrasting trim on the collar and cuffs, as well as reinforcing cotton patches over the side vents.

51LDPC565NV – Navy £25.00
 51LDPC565GM – Grey Marl £25.00
 51LDPC565RD – Orange £25.00





1.

2.

3.

1. GIRLS' FULL ZIP HOODIE

Little adventurers will love this casual hoodie. Made from a soft, brushed cotton jersey, it features a wide fitting hood and contrasting side panels and piping.

51LDEC574PU – Plum £40.00

2. GIRLS' T-SHIRT

Everyday tee for non-stop fun. Made from cotton jersey with soft handle adventure print and short sleeves. Featuring Land Rover inspired print inside back neck.

51LDTC572GN – Green £18.00
 51LDTC572PU – Purple £18.00
 51LDTC572WT – White £18.00

3. GIRLS' QUILTED JACKET

Ultra-warm and super-cool. This jacket features diamond pattern quilting and Land Rover Adventure print lining with detailing to sleeves and pockets.

51LDJC569NV – Navy £60.00



4.



5.



4. TOY DEFENDER

A rugged toy Defender by Bruder with removable roof rack, moving wheels and doors that open. Comes with a toy horse and detachable horse box.

51TOADHT £45.00

5. CHILDREN'S ADVENTURE BEAR

The friendly bear they can take on tour. Dressed in shorts and shirt, with an explorer's hat and messenger bag. Makes the perfect travel companion.

51LRAVENTUREBEAR £35.00

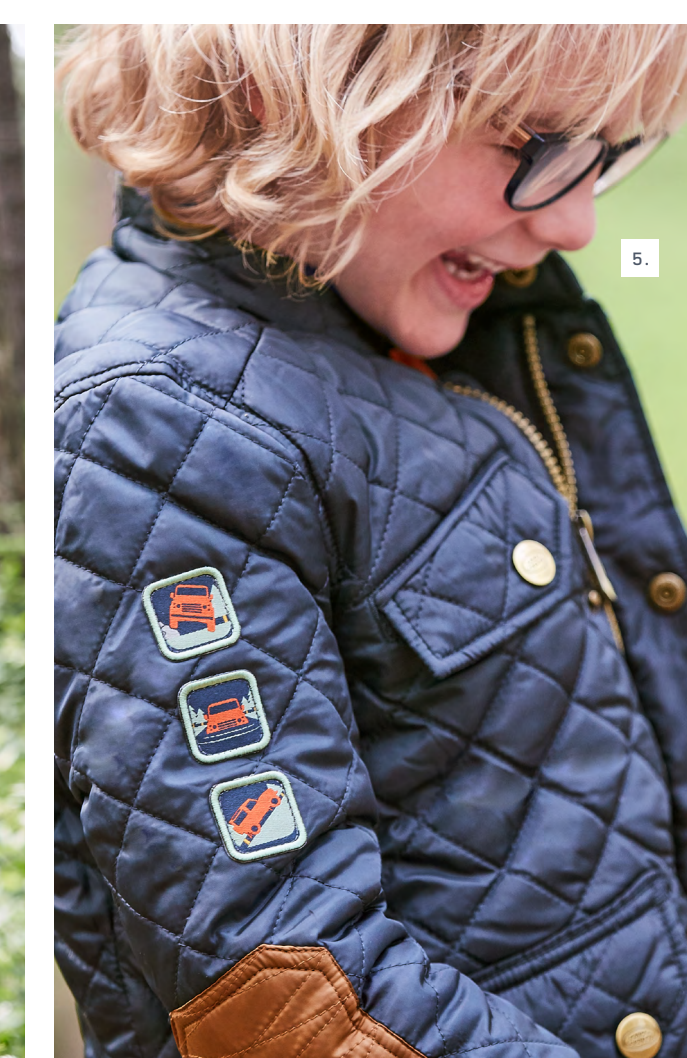
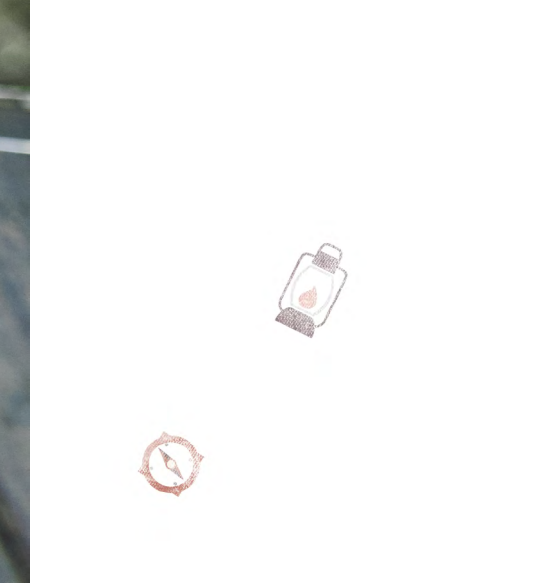

1. CHILDREN'S HAT/SCARF/GLOVE SET

A matching set of woollen warmers. Featuring a Pink and Purple hat, scarf and Magic Gloves that stretch to fit. With Outdoor Adventure graphic, ribbed detailing and a woven side-tab.

51LDGF640PUA – Purple £25.00

2. GIRLS' QUILTED JACKET

Ultra-warm and super-cool. This jacket features diamond pattern quilting and Land Rover Adventure print lining with detailing to sleeves and pockets.

51LDJC569NV – Navy £60.00

3. CHILDREN'S BACKPACK

A backpack that packs in lots of fun, with a Junior Defender print. Fitted with wide, comfortable straps and a separate drinks pocket.

51LDGF581GNA – Green £20.00



4. CHILDREN'S HAT/SCARF/GLOVE SET

A matching set of woollen warmers. Featuring a Navy and Orange hat, scarf and Magic Gloves that stretch to fit. With Outdoor Adventure graphic, ribbed detailing and a woven side-tab.

51LDGF639NVA – Navy £25.00

5. BOYS' QUILTED JACKET

A grown-up jacket with boyish good looks. Sports diamond-pattern quilting and a Land Rover Adventure print to the inside. Comes with brass-effect poppers throughout.

51LDJC563NV – Navy £60.00





RANGE ROVER RIDER

Get junior drivers started early at the wheel of a Range Rover Rider. A kids' ride-on car with all the hallmarks of stylish Range Rover design. Packed with pint-size fun, it offers a comfy seat, working front and rear LED lights and a seriously smooth ride.



RANGE ROVER RIDER

The perfect transport for little big adventures. This ride-on car sports working front and rear LED lights, low-noise tyres and a soft-touch seat. Suitable for children 18-36 months. Lights powered by 3 x AA batteries (not included).

51LDTY926RDA - Red £140.00
51LDTY926WTA - White £140.00

HERITAGE



COLLECTION

PIONEER

The first Land Rover to roll off the production line bore a legendary number plate: Hue 166. To commemorate this historic model, the Heritage Collection brings together a range of exclusive memorabilia. Taking design cues from the Series 1, these gifts and accessories recall the birth of a true adventurer.

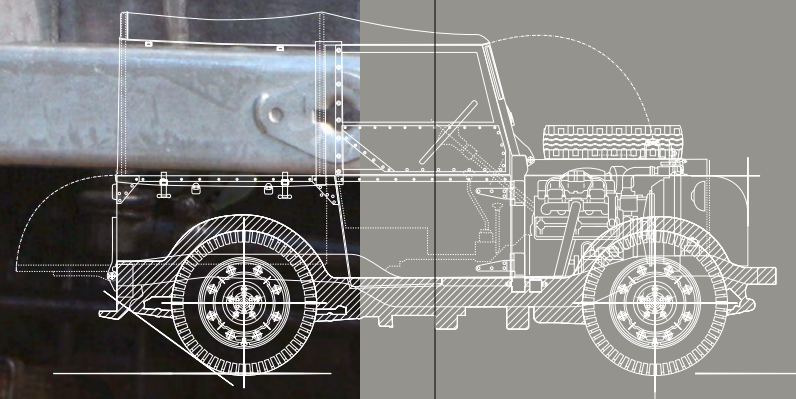



1. MEN'S HUE GRAPHIC T-SHIRT

Vintage-effect T-shirt with technical graphic print to chest. Made from 100% cotton jersey with split side-vents. Features contrast stitching to neck and hemline and iconic number plate tab on hem.

- 51LDTM558WT – White £25.00
- 51LDTM558BK – Black £25.00
- 51LDTM558GY – Grey £25.00



2. BOYS' HUE GRAPHIC T-SHIRT

What every little Huey wants. In 100% cotton jersey with technical drawing of the famous Hue 166 on the chest. HUE woven label to the hem.

- 51LDTM558WT – White £25.00
- 51LDTM558BK – Black £25.00
- 51LDTM558GY – Grey £25.00

3. HUE CERAMIC DOG BOWL

Ceramic Hue dog bowl that makes mealtimes memorable. Featuring HUE number plate with relief border. Made in the original Series I Grasmere Green colour.

- 51LDPT788GNA – Grasmere Green £20.00





1.



4.

5.



2.



3.

1. HUE TEDDY BEAR

Children's soft toy dressed in heritage Hue 166 overalls and tweed flat cap. Sporting Land Rover logo, he makes a popular Land Rover gift for any child.

51LDTY618BNA – Brown £35.00

2. HUE MUG

Start your day's journey with this ceramic mug in Grasmere Green, featuring the Hue 166 logo with relief border. Safe for microwaves and dishwasher.

51LRCEAHUEB – Black £12.00
 51LRCEAHUEG – Grasmere Green £12.00
 51LRCEAHUEW – White £12.00

3. HUE CUFFLINKS

Stylish Silver and Black cufflinks with Hue 166 number plate logo.

51LDCL560BKA – Black £35.00

4. HUE NOTEBOOK SMALL A6

Made with eco-friendly stone paper that's tough, tear resistant, greaseproof and waterproof, this A6 notebook features the Hue 166 number plate logo. Includes a Hue technical drawing to the inside.

51LDNB561GNA – Green £3.00

5. HUE NOTEBOOK AND ORGANISER

Take note. This Hue canvas notebook and organiser has a Grey contrast stitch and versatile pocket storage. Features a Hue 166 woven badge.

51LDNB562GNA – Green £15.00



SYNCHRONISE

When it comes to other watches, don't waste your time. Our Land Rover collection is everything you expect from a timepiece. Style, precision and accuracy. It's a piece of Land Rover engineering that you can take with you everywhere.

LAND ROVER CLASSIC WATCH

Classic watch with timeless style. Features an Italian leather strap and date aperture. Finished with Land Rover wordmark branding.

51LEWM312BKA £150.00



LAND ROVER CHRONOGRAPH WATCH

Solar powered watch that charges through the dial. Featuring chronograph sub-dials with Orange detailing and rubberised strap. Runs for up to 4 months on a full charge.

51LEWM313BKA £255.00



LAND ROVER HERITAGE WATCH

Required expedition wear. This watch comes with a classic NATO strap, date aperture and Heritage branding.

51LEWM314NVA £175.00





DEPART

Going somewhere? We have a piece of luggage to suit your every adventure. Crafted from hard-wearing leather and tough nylon, these bags are packed with all the quality you'd expect from Land Rover. Made with the kind of attention to detail that will ensure years of service.

**LAND ROVER CARRY ON TROLLEY**

Don't leave home without this easy-rider, wheeled duffel case. Made from hard-wearing nylon and leather trim. With a waterproof pocket and separate inner compartments.

51LBU355BKA – Black £295.00
W 37cm H 59cm D 23cm

LAND ROVER WEEKENDER BAG

The go-to bag for weekend adventures. Made with rugged Black nylon, leather trim and handy zip compartments inside and out. Features detachable shoulder strap and a waterproof pocket.

51LBU352BKA – Black £195.00
W 50cm H 19cm D 32cm

**LAND ROVER BRIEFCASE**

A briefcase that's not scared of hard work. Practical and stylish with leather trim. It features an easy-access front pocket with a detachable shoulder strap.

51LBU354BKA – Black £155.00
W 39cm H 33cm D 12cm

LAND ROVER RUCKSACK

Treat your back to a little luxury. This slick nylon rucksack with leather trim comes equipped with adjustable straps, and a waterproof pocket to help keep electronics safe and dry.

51LBU351BKA – Black £140.00
W 31cm H 44cm D 13cm



DOG WAX JACKET

Keep your best friend safe from the elements in this water-resistant coat. Made with Barbour for Land Rover tartan, it features a collar that lifts for extra protection.

S	51BEPT289OLC – Brown	£45.00
M	51BEPT289OLD – Brown	£45.00
L	51BEPT289OLE – Brown	£45.00
XL	51BEPT289OLF – Brown	£45.00



DOG COLLAR

A collar that takes style up a notch. Featuring an exclusive Barbour for Land Rover tartan. Leather-lined with aged brass-effect metal fittings.

S	51BEPT284MXC – Tartan	£45.00
M	51BEPT284MXD – Tartan	£45.00
L	51BEPT284MXE – Tartan	£45.00



DOG LEAD

Made from genuine leather, this dog lead is the real thing. With contrast top stitching and aged brass-effect fittings. Featuring an exclusive Barbour for Land Rover tartan.

ONE SIZE	51BEPT285MXA – Tartan	£40.00
----------	-----------------------	--------

FETCH

Do your best for your best friends, with genuine Barbour accessories for dogs made specially for Land Rover. Choose from hard-wearing leads and dog collars, or keep the rain off them with their very own classic wax jackets. These are pure-bred accessories that really make a dog's life.

REFER TO SIZE GUIDE ON PAGE 69



COLLECT

What could be more collectible than a scale model of a Land Rover? Beautifully designed with carefully reproduced details, these special-edition pieces are created for true Land Rover enthusiasts everywhere. The only time it's acceptable to leave a Land Rover on the shelf.

LAND ROVER DEFENDER MOVIE EDITION (1:18)

A meticulously detailed resin 1:18 scale model which is sure to be the centrepiece of any collection. A replica of a Defender TD5 110 converted by Land Rover Special Vehicle Operations for film use. A faithful reproduction of the original by Kyosho.

51LDDC948GYW – Corris Grey £199.99



LAND ROVER DEFENDER FINAL EDITION ADVENTURE (1:18)

1:18 scale model. A collector's grade die-cast of the much loved Defender Final Edition Adventure. A finely detailed example for discerning collectors.

51LDLC035ORW – Orange/Black £125.00



LAND ROVER SERIES I HUE 166 (1:43)

1:43 collector's grade scale model. Based on the original 1948 Land Rover Series I Defender, famed for its strength, durability and unmistakable silhouette. A highly detailed and beautifully crafted model.

51LRDCAHUE – Grasmere Green £80.00



RANGE ROVER EVOQUE 3 DOOR (1:43)

A die-cast 1:43 collector's grade scale model.

51LRDCA3EVOQ – Fuji White £50.00

51LRDCA3EVOQR – Firenze Red £50.00



**RANGE
ROVER**

COLLECTION

ENGAGE

Stylish. Understated. Exclusive. Meet a collection that draws attention, but does it quietly. From wallets to iPad cases, these pieces are impervious to the passage of time and the vagaries of fashion. Made from the highest quality leather and handcrafted to suit every urban expedition.





**1. RANGE ROVER LEATHER
IPAD FUNCTIONAL CASE**

A superbly crafted iPad case that doubles as a magnetised stand. Made from smooth leather and suitable for iPad Air 2 and iPad Pro. Available in Black and White with contrasting logo details.

51LDLG829BKA – Black £95.00
51LDLG855WTA – White £95.00

**2. RANGE ROVER LEATHER
IPHONE WALLET PHONE CASE**

Elegant leather iPhone wallet case with three card slots. Finished with embossed Range Rover logo. Available in White and Black leather. Suitable for iPhone 6, 6 Plus, iPhone 7, 7 Plus, iPhone 8 and 8 Plus.

iPhone 6
51LDPH856WTA – White £70.00
651LDPH856BKA – Black £70.00

iPhone 6 Plus
51LDPH668BKA – Black £70.00

iPhone 7
51LDPH857WTA – White £70.00
51LDPH857BKA – Black £70.00

iPhone 7 Plus
51LDPH858WTA – White £70.00
51LDPH858BKA – Black £70.00

iPhone 8
51LEPH226WTA – White £70.00
51LEPH226BKA – Black £70.00

iPhone 8 Plus
51LEPH227WTA – White £70.00
51LEPH227BKA – Black £70.00



3. RANGE ROVER KEY RING

Key ring crafted from polished chrome with a split ring and ring connector. Features characteristic Range Rover Gear Bezel design with knurled finish.

51LBKR228BKA – Black and Silver £45.00
51LDKR826WTA – White and Rose Gold £45.00

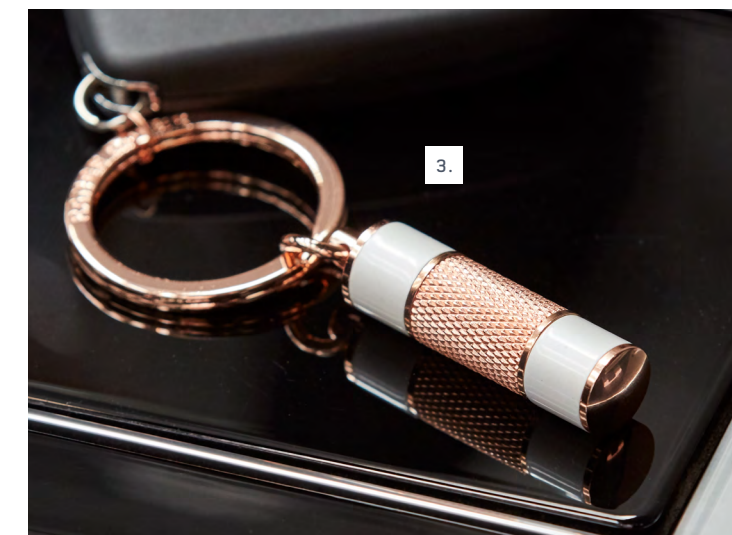



1. RANGE ROVER CUFFLINKS

Stylish cufflinks with knurling detail inspired by the Range Rover Gear Bezel design. Designed with coloured inlay and laser-engraved Range Rover wordmark. Available in Black and Navy.

51LBCL229BKA – Black £60.00
51LDCL675NVA – Navy £60.00



2. RANGE ROVER CARD HOLDER

A neatly proportioned card holder in smooth black leather. Comes with a centre compartment and four card slots. Silver foiled Range Rover logo embossed on the front.

51LDLG672BKA – Black £45.00

3. RANGE ROVER PASSPORT HOLDER

Wherever your adventures take you, travel in style with this smooth leather passport holder featuring the embossed Range Rover logo on the front.

51LDLG673BKA – Black £60.00

4. RANGE ROVER WALLET

Smooth leather wallet. Includes two bank note compartments and eight card slots. With contrasting blue note dividers and silver foiled Range Rover logo to the front.

51LDLG669BKA – Black £70.00

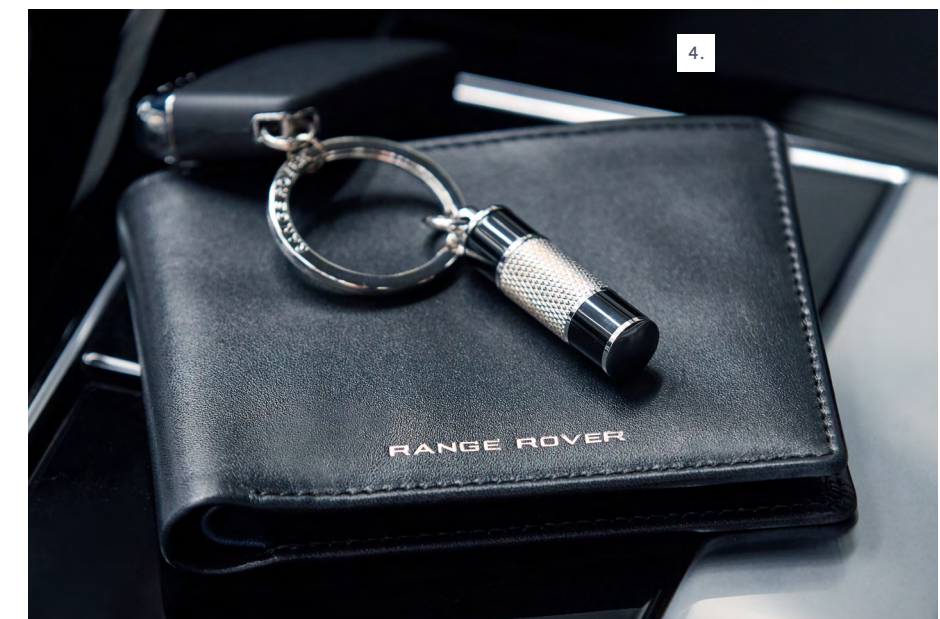

CLOTHING SIZE GUIDE

UK MEN'S	CHEST (CM)	UK WOMEN'S	BUST (CM)
XS	88	8	77
S	92	10	82
M	97	12	87
L	102	14	92
XL	107	16	97
XXL	112	18	102
XXXL	117	20	107
XXXXL	122		

UK BOYS'	CHEST (CM)	UK GIRLS'	CHEST (CM)
2 YRS	54	2 YRS	52
3-4 YRS	58	3-4 YRS	56
5-6 YRS	62	5-6 YRS	60
7-8 YRS	66	7-8 YRS	64
9-10 YRS	70	9-10 YRS	68

DOG COAT SIZE GUIDE

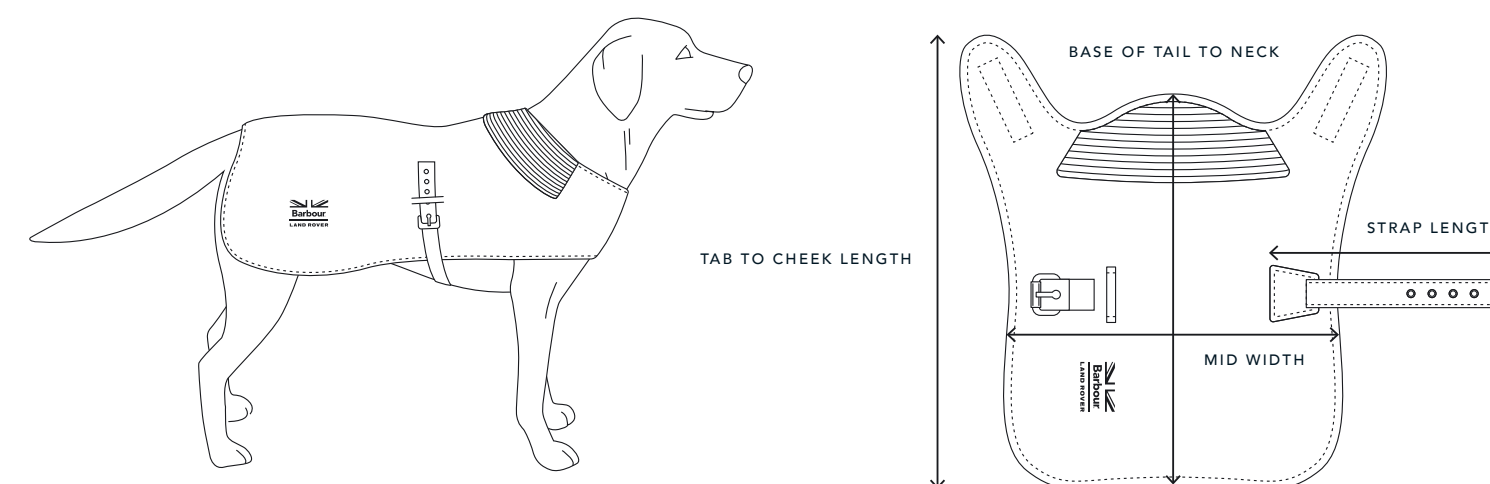

SIZE	S	M	L	XL
BREED	Terrier	Spaniel	Retriever	Pointer
NECK TO TAIL	35cm	45cm	55cm	66cm
MID WIDTH	30cm	38cm	46cm	55cm
TAB TO CHEEK LENGTH	44cm	57cm	70cm	82cm
STRAP LENGTH	26cm	34cm	43cm	52cm

DOG COLLAR SIZE GUIDE

SIZE	S	M	L
COLLAR MEASUREMENTS	14mm x 40cm	19mm x 53cm	25mm x 63.5cm
TO FIT NECK	27.5cm x 35.5cm	36cm x 46mm	47cm x 56.5cm

Find us at:
shop.landrover.co.uk
Or visit your local retailer

Registered Office:
Abbey Road, Whitley, Coventry CV3 4LF
Registered in England No: 1672070.
VAT Registration No: GB927153228.